

DIACloud Training

DIACloud

IABG – 2020





Agenda

- **Preparazione alla formazione**
- **DIACloud website**
 - **Creare un Account (Utente) e un Tunnel sicuro**
 - **Collegamenti**
- **Configurazione del router DX**
- **Eventi di allarme**



Preparazione

.....Prima di iniziare

DX series router	<ul style="list-style-type: none"> • DX-2100RW-WW 3G Router • DX-2300LN-WW Ethernet Router 	
DIACloud Account	<ul style="list-style-type: none"> • www.diacloudsolutions.com 	
DIACom / DIADevice	<ul style="list-style-type: none"> • www.deltaww.com 	
DIACloud APP		
3G SIM (operatore telefonico)		Codice PIN deve essere disabilitato
Manuali	<ul style="list-style-type: none"> • www.deltaww.com, Download center 	

DX-2100RW-WW vista generale

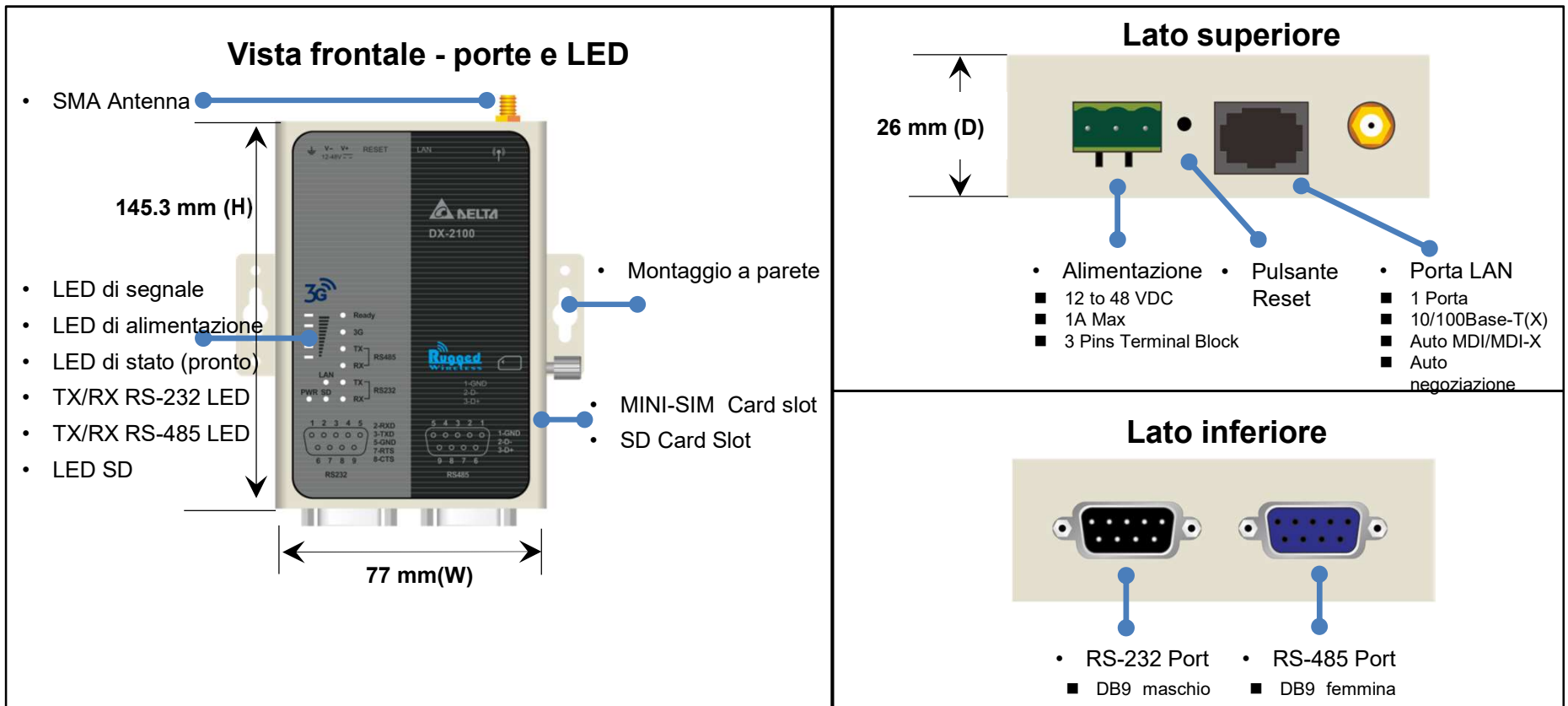

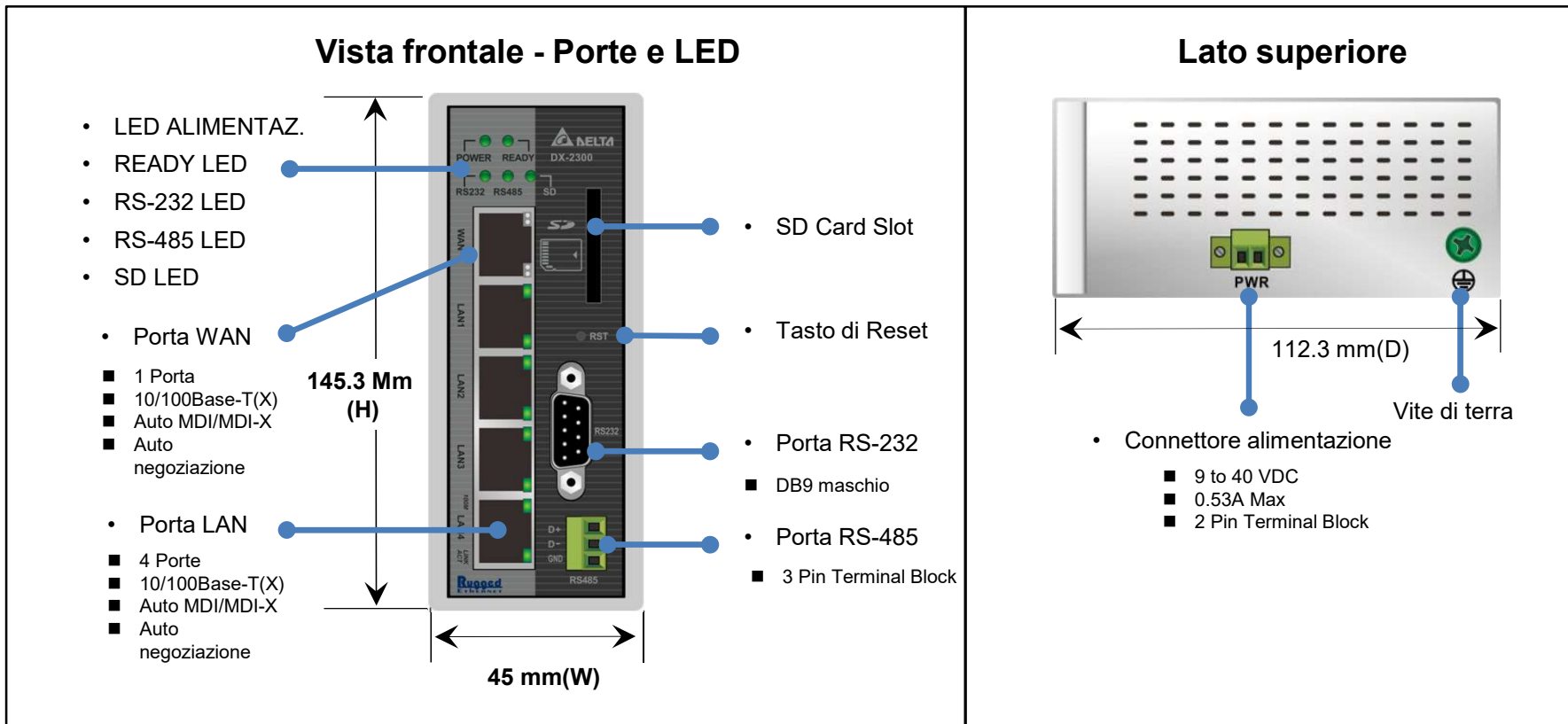

1 Creare un account e un Tunnel Sicuro

- www.diacloudsolutions.com

2 Associare il dispositivo

- Associare il DIACloud al DX router e al DX webserver

3 Configurazione Dispositivo

- Ethernet e porta seriale
- Configurazione della mappa Dati
- Configurazione DIACom
- Configurazione eventi di allarme



1. Creare un Account (Utente) e un Tunnel Sicuro



Creare un utente DIACloud

1. <http://www.diacloudsolutions.com>

 Si raccomanda Google Chrome

2. Introdurre le informazioni richieste

3. Attivare l'utente

4. Utente attivato



WAN = Wide Area Network

ARCHITETTURA



INTERNET

INTERNET

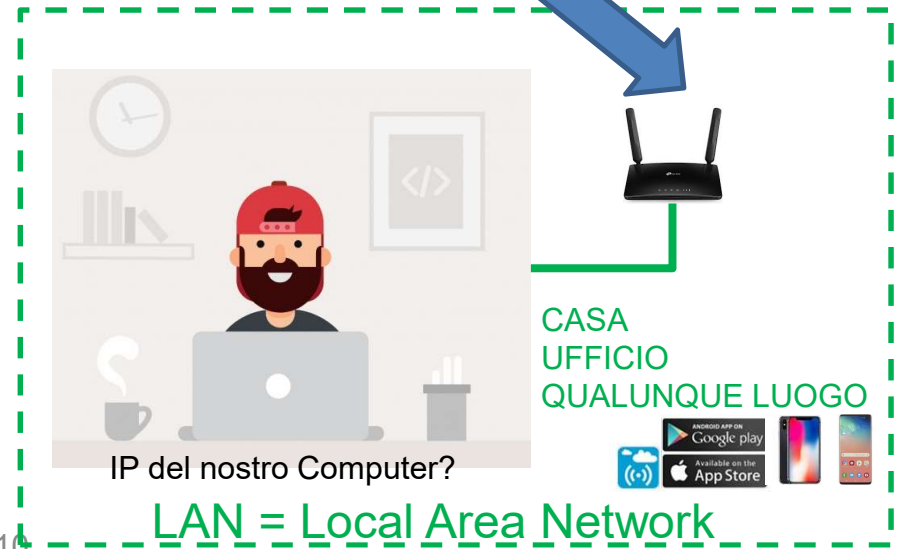
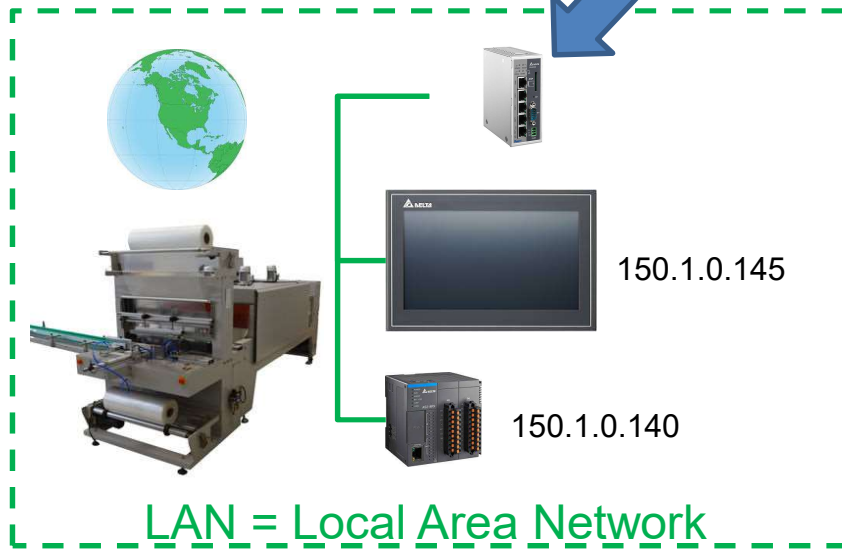



CONNESSIONE INTERNET
IP IN FUNZIONE DEL FORNITORE
DI ACCESSO A INTERNET

CLOUD

CONNESSIONE INTERNET
IP IN FUNZIONE DEL FORNITORE
DI ACCESSO A INTERNET



SCHEDA DI RETE O WI-FI
PORTA ETH VIRTUALE

IP ALL'INTERNO DEL TUNNEL PER
IL COLLEGAMENTO REMOTO
ALL'APPARECCHIATURA

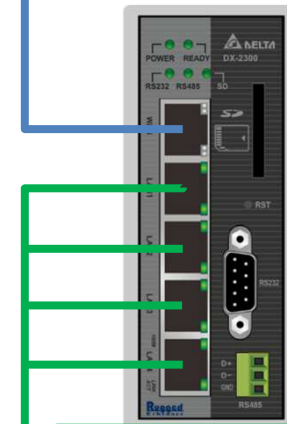

IP ALL'INTERNO DEL TUNNEL PER
IL COLLEGAMENTO REMOTO
ALL'APPARECCHIATURA

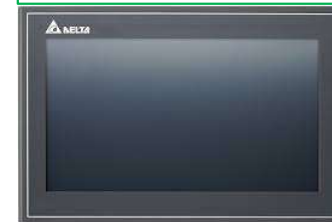

SCHEMA DELLA RETE



Scheda di rete del nostro PC nella LAN di casa / ufficio con IP a seconda del nostro provider di accesso a Internet, ad esempio 192.168.0.15



Devo definire chiaramente la classe del mio IP

TUNNEL VPN:
IP START: 150.1.0.100
IP END: 150.1.0.255

Adattatore Ethernet DiaCom (porta Ethernet virtuale creata sul nostro PC) con IP all'interno del range del tunnel che abbiamo creato, ad esempio 150.1.0.189

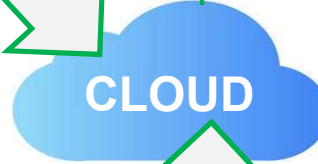

IP del router per la connessione al cloud, a seconda del provider di accesso a Internet, ad esempio 128.80.1.80



IP del router nella VPN all'interno dell'intervallo del tunnel definito, ad esempio 150.1.0.167



150.1.0.140



150.1.0.145

COME NORMA GENERALE NON DEFINIAMO MAI UN TUNNEL CON UN RANGE IP UGUALE ALL'IP FISICO DELLA NOSTRA CONNESSIONE INTERNET SUL PC



Creare Tunnel Sicuro

<http://www.diacloudsolutions.com/>

1. Identificarsi con l'account che abbiamo appena creato

The login form is titled "DIACloud" and is set against a blue background. It contains the following elements:

- Email field: "Email*" with the value "dortega@deltaww.com".
- Password field: "Password*" with masked characters "*****".
- Remember Me checkbox: Checked.
- LOGIN button: A red button.
- Links: "CREATE AN ACCOUNT" and "FORGOT PASSWORD?".
- Contact Us: "Contact Us: web@diacloudsolutions.com".

2. Selezionare SECURE TUNNELS

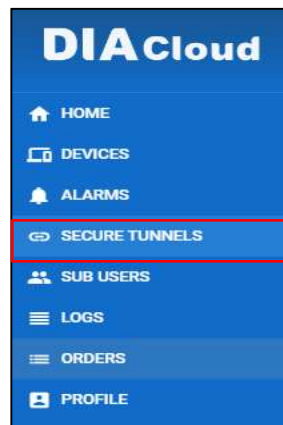

3. Click su "+" per creare un Tunnel sicuro

The screenshot shows a table with a search bar and a "+" button. The table contains one row of data:

#	Tunnel Name ↑	DHCP	DHCP IP Range	Status	Operation
1	Default	Enabled	192.168.200.100 192.168.200.200	Normal	...

Total 1 secure tunnel(s)

Configurazione del Tunnel sicuro

4. Creare il tunnel

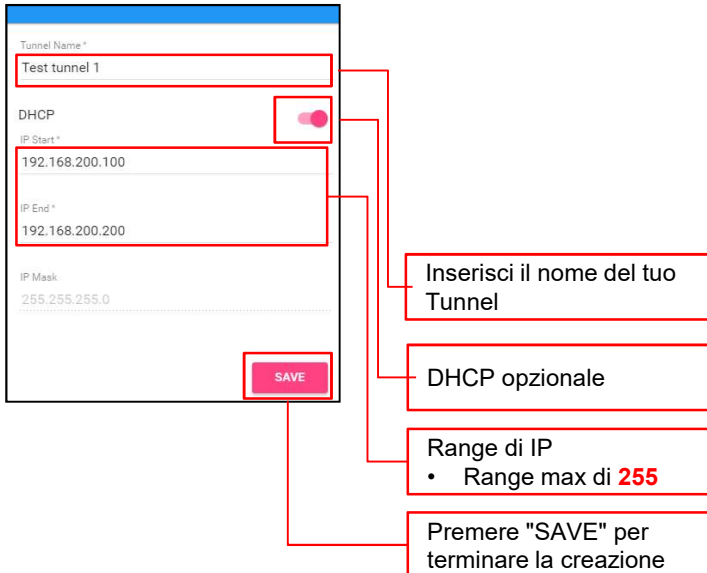

Tunnel Name*
 Test tunnel 1

DHCP

IP Start*
 192.168.200.100

IP End*
 192.168.200.200

IP Mask
 255.255.255.0

SAVE

Inserisci il nome del tuo Tunnel

DHCP opzionale

Range di IP
 • Range max di **255**

Premere "SAVE" per terminare la creazione

5. Lista tunnel e possibilità di eliminarli

#	Tunnel Name ↑	DHCP	DHCP IP Range	Status	Operation
1	Test tunnel 1	Enabled	192.168.200.100 192.168.200.200	Normal	...



Tunnel Name*
 Test tunnel 1

DHCP

IP Start*
 192.168.200.100

IP End*
 192.168.200.200

IP Mask
 255.255.255.0

SAVE

Fare clic per modificare i tunnel creati

Eliminare tunnel

Per esportare il tunnel

- Copia da SD card al DX router
- Copia su scheda SD dal router DX



2. Associare il dispositivo

Login DX Router Webserver

1. Modificare le impostazioni di rete del PC

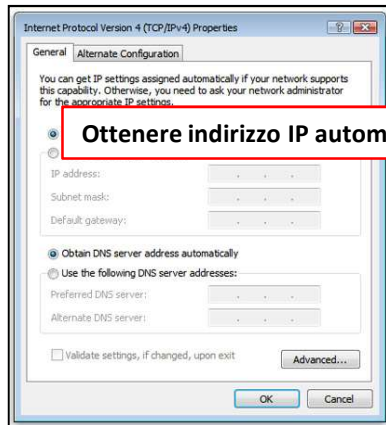

2. Connettere il PC al router DX con cavo ethernet



3. Login DX router

<http://www.diadevice.com/login.html>

O rilevare il dispositivo con lo strumento DIADevice

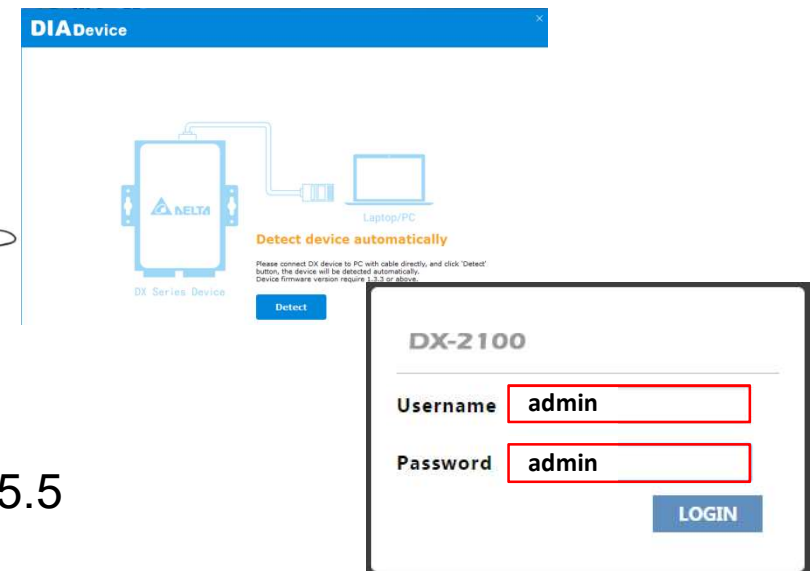

Indirizzo IP predefinito del router DX: 192.168.5.5



OPZIONE 1: Collegare il dispositivo al DIACloud con lo strumento DIADevice

1. Lanciare DIADevice rilevare il dispositivo ed effettuare il Login



username & password predefinite: "admin"

2. Associare il dispositivo



1. Associare il dispositivo (Bind device)

N.B. La SIM inserita non deve avere la Password o il PIN

3. Associare ad un account DIACloud

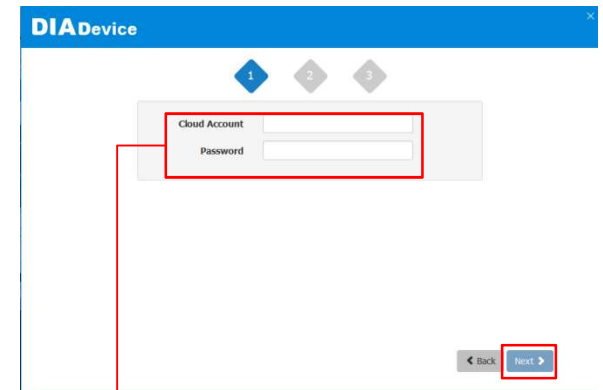

1. Introdurre account e password del DIACloud
2. Cliccare su "Next".



OPZIONE 1: Associare il dispositivo al DIAcloud con lo strumento DIADevice

4. Associare il dispositivo ad un tunnel sicuro

Cloud Account: adova@deltaww.com
Device Name: **DIK2190_F98**
Secure Tunnel: **default_tunnel**
Cloud DHCP: Enabled
Retrieve IP address from cloud: Yes

< Prev Bind >

Selezionare il tunnel che è stato definito nel DIACloud website.

1. Definire il nome del dispositivo
2. Questo nome verrà utilizzato nel DIACloud website per la gestione e configurazione del dispositivo.

5. Associazione confermata

Succeed in binding device.

The device had been bind to account adova@deltaww.com
Device LAN IP address is **192.168.200.136**
Now you may login to www.diacloudsolutions.com to check the device

Finish



OPZIONE 2: Vincolare il dispositivo al DIACloud via Webserver

1. Selezionare CLOUD SERVICE

2. Inserire l'account da vincolare

Seleziona il tunnel che hai definito nel DIACloud website.

1. Definire il nome del dispositivo
2. Questo nome verrà utilizzato nel DIACloud website per la gestione e configurazione del dispositivo.

3. Associazione Account



OPZIONE 2: Vincolare il dispositivo al DIACloud via Webserver

4. Iniziare processo di vincolo

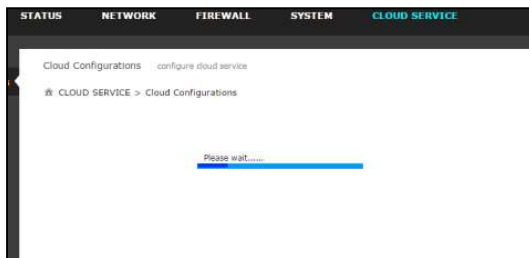

Attendere il processo di vincolo (1 minuto apr.)



5. Il vincolo è completato quando compare la finestra di login

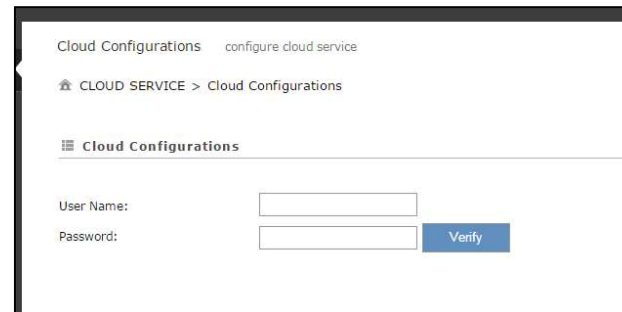



Verifica via DIACloud Webserver

4. Entrare nel DIACloud <http://www.diacloudsolutions.com> e verificare il vincolo

The screenshot shows the DIACloud dashboard. On the left is a navigation menu with items: HOME, DEVICES, ALARMS, SECURE TUNNELS, SUB USERS, LOGS, ORDERS, and PROFILE. The main content area has two summary cards: 'Devices in Total' with a large blue '1' and 'Devices is Online' with a large green '1'. A red box highlights these two cards. Below them, another red box contains the text: 'Il dispositivo è stato vincolato col suo account.'

The screenshot shows a table titled 'Secure Tunnels' with a search bar and a filter dropdown set to 'All'. The table has columns: #, Device Name, SN, Device Type, Storage Usage, Data Usage, Created, and Operation. A red box highlights the first row of data.

#	Device Name	SN	Device Type	Storage Usage	Data Usage	Created	Operation
1	PLC	DXR02010F270086	DX2100	0.07 MB	37.96 MB	2016-06-09 10:52	...

Total 1 Device(s)

Verificare le impostazioni del DX Router

The screenshot shows the configuration page for a PLC device. The top bar has 'PLC' and navigation icons. Below are tabs for OVERVIEW, REGISTERS, SERVICES, and MORE. The OVERVIEW tab is active, showing various settings. A red box highlights the 'IP Address' field with the value '192.168.200.135'. Another red box highlights the 'Secure Tunnel' field with the value 'Test tunnel 1'. A third red box highlights the 'RS232 Mode' field with the value 'Closed'. A fourth red box highlights the 'RS485 Mode' field with the value 'Transparent'. A fifth red box highlights the 'Modbus TCP' field with the value 'Client'. The 'Boot Time' is '2016-6-9 10:07 (+8)'. There is also an 'RSSI' section with a signal strength indicator and a 'Latest Alarms' section at the bottom.



Verifica da APP DIACloud



1. Login DIACloud APP

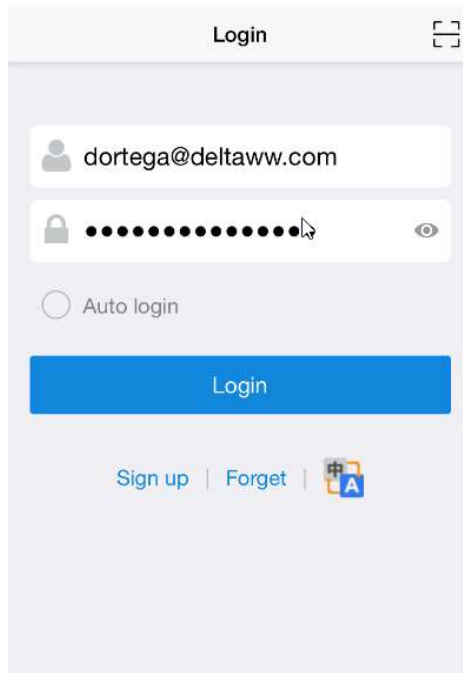

2. Lista dispositivi

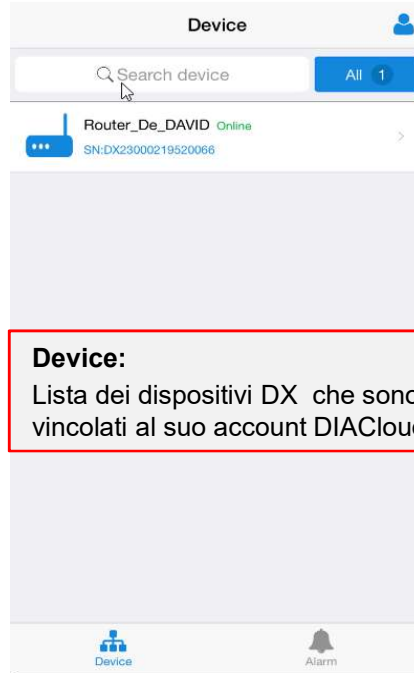

Device:

Lista dei dispositivi DX che sono vincolati al suo account DIACloud.

3. Dettagli del dispositivo

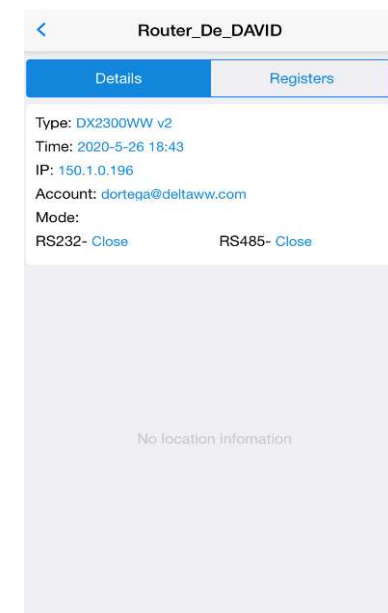

Localizzazione del dispositivo solo disponibile con DX-2100



3. Configurazione del dispositivo

- Porta seriale e configurazione Ethernet
- Configurazione mappa dei Dati
- Configurazioni DIACom
- Configurazione eventi di allarme



3.1 Porte seriali e configurazione Ethernet



Configurazione porta Ethernet

1. Selezionare opzione "SYSTEM"

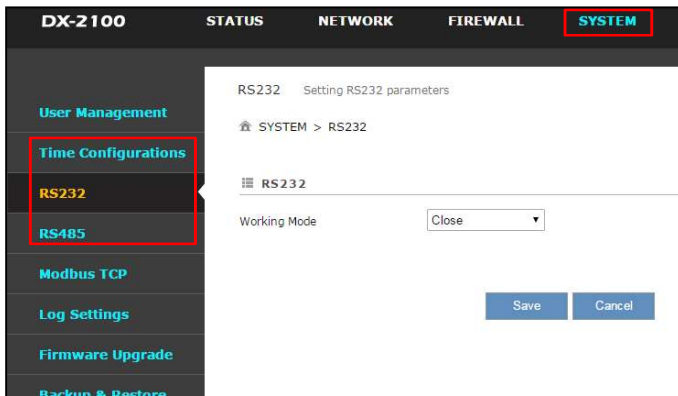

2. Scegliere il protocollo di lavoro RS-232/RS-485 e MODBUS TCP

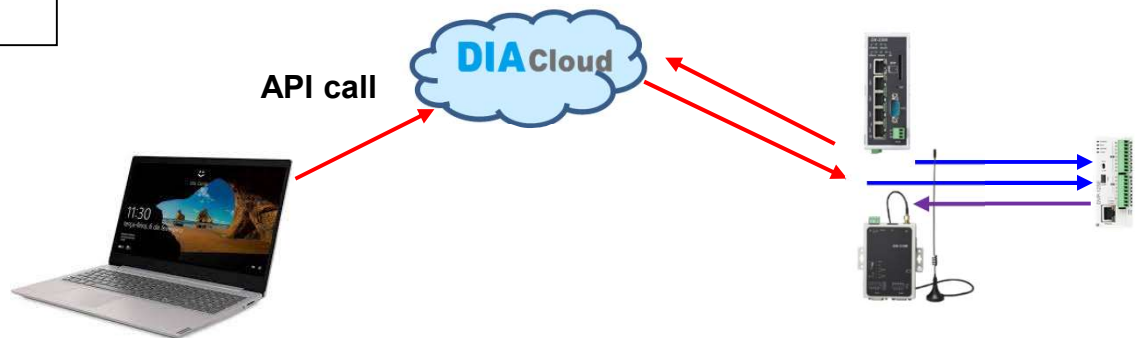
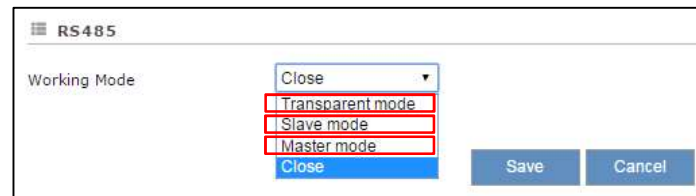



Configurazione porta seriale

RS-232/RS-485 modo Slave

Working Mode: Slave mode

Baud Rate: 9600

Data Bits: 7

Stop Bits: 1

Parity Bits: Even

Flow Control: None

Modbus ID: 1

Modbus Mode: ModBus RTU

Modbus Timeout: 200 (ms)

200ms~5000ms

Save Cancel

- Slave ID: 1~255
- Slave Starting Address: 0~65535

RS-485 modo Master

Working Mode: Master mode

Baud Rate: 9600

Data Bits: 8

Stop Bits: 1

Parity Bits: None

Modbus ID: 1

Modbus Mode: ModBus RTU

Modbus Timeout: 1000 (ms)

200ms~5000ms

Read/Write Configuration

Scan Interval: 500 (ms)

20ms~60000ms

Setting Address: address is decimal, taking care to avoid conflicts with address set in other feature!

Add Mappings

Read/Write	Slave ID	Slave Starting Address	Device Starting Address(2048-4095)	Length(1-123)	Operation
Write	1	2048	2048	1	Delete
Read	1	2049	2049	1	Delete
Write	1	2050	2050	1	Delete

Save Cancel



MODBUS TCP

DX-2300 STATUS NETWORK FIREWALL SYSTEM CLOUD SERVICE

User Management
Time Zone Settings
RS232
RS485
Modbus TCP
Log Settings
Firmware Upgrade
Backup & Restore
Scheduled Jobs
Network Diagnosis
System Reboot
Event Management
Register Management

Modbus TCP Setting modbus TCP parameters

SYSTEM > Modbus TCP

Modbus TCP Client Setting

Server IP: 150.1.0.140 **IP del PLC**
Server Port: 502 **Porta comunicazione Modbus TCP**
Response Timeout: 300 (ms)

Read/Write Configuration

Scan Interval: 1000 (ms) **Frequenza di aggiornamento**

- When communicate with PLC of Delta, the starting address can be set as the internal register number. For example, input 0 for register D0.
- The acceptable address range of this device is from 2048 to 4095 in decimal.

Add Mappings

Row Number	Read/Write	Slave ID	Controller	Address Type	Slave Starting Address	Device Starting Address(\$2048-\$4095)	Length(1-123)	Operation
1	Read/Write	1	Delta AS PLC	D	0	\$2048	10	Delete

Save Cancel

Copyright © 2015 Delta Electronics, Inc. All Rights Reserved.

Configurazione Ethernet

Modbus TCP Setting modbus TCP parameters

SYSTEM > Modbus TCP

Modbus TCP

Working Mode: Modbus TCP Client **Confirm**

*4 modbus TCP servers supported at most **Add Server**

Row Number	Server IP	Server Port	Response Timeout(ms)	Scan Interval(ms)	Operation
1	150.1.0.140	502	300	1000	Edit Delete



3.2 Configurazione mappa dei Dati



Concetto di mappa dati

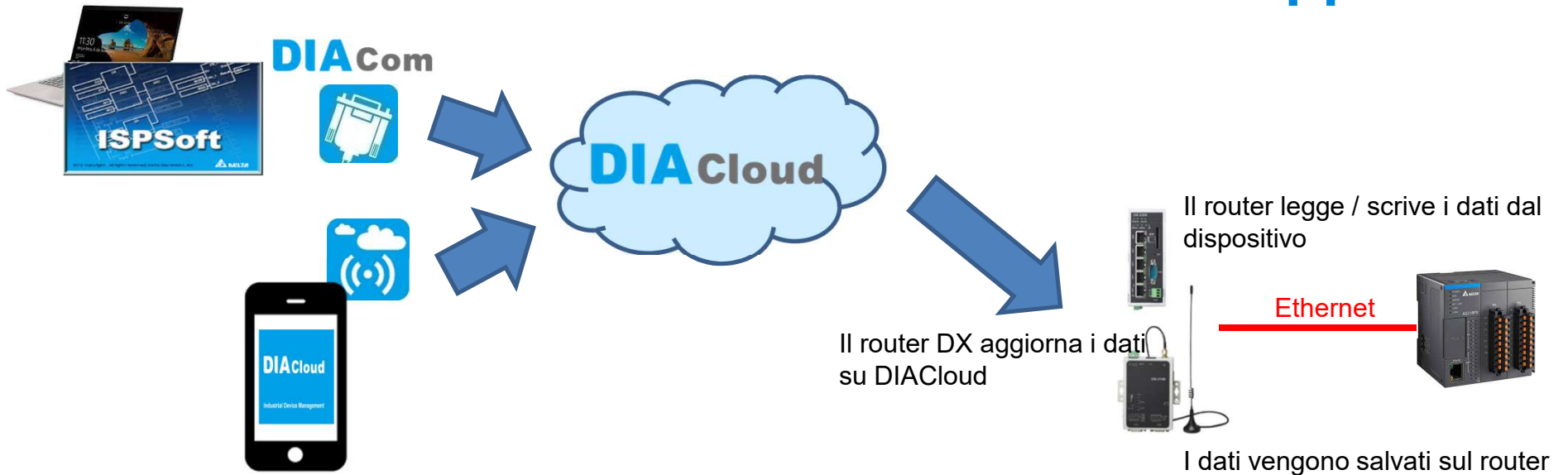

Tramite software di programmazione PLC o APP mobile



Mappatura dei Dati sul DIACloud

1. Selezionare “SYSTEM” → “Register Management”

The screenshot shows the 'SYSTEM' menu highlighted in red. Below it, the 'Register Management' page is displayed, featuring a table with the following data:

ID	Register Start Address	Length	Upload To Cloud	History Data	
1	\$2048	1	Yes	No	Edit Delete
2	\$2049	1	Yes	Yes	Edit Delete

2. Aggiornare dati al DIACloud

The screenshot shows the 'Add Registers' form with the following fields and annotations:

- Register Start Address:** Input field containing '\$2048-4095'. Annotation: "Registro di inizio".
- Length:** Input field. Annotation: "Quantità: 1-2048".
- Uploaded To Cloud:** Dropdown menu set to 'Yes'. Annotation: "Scelta se sovrascrivere dato".
- Keep History:** Dropdown menu set to 'No'. Annotation: "Aggiornare solamente al cambiamento di valore".

Buttons for 'Save' and 'Back' are visible at the bottom right.



Controllare il registro del DX nel DIACloud

1. Selezionare "Device"

#	Device Name ↑	SN	Device Type	Storage Usage	Data Usage	Created	Operation
1	PLC	DXR02010F270086	DX2100	0.07 MB	39.91 MB	2016-06-09 10:52	...

Total 1 Device(s)

Premere per altro

2. Selezionare "Register" e premere l'icona "... " per configurare o cancellare il registro

DX2100_F0F8

OVERVIEW **REGISTERS** SERVICES MORE

Search	1/1	
\$2048	376 2017-02-09 12:45	⋮
\$2049	502 2017-02-09 12:38	⋮

Delete
Config

3. Aggiungere un nome al registro se desiderato

Register Configuration

Register Address
2049

Alias Name*
Temperature_Oven_1

function(val) {
JavaScript Template
return val;
}

SAVE

"nome" del registro



Editare Registro in DIACloud e APP

Editare registro in DIACloud

The screenshot shows the DIACloud web interface. At the top, there's a header with 'DX2100_F0F8' and navigation icons. Below it, there are tabs for 'OVERVIEW', 'REGISTERS', 'SERVICES', and 'MORE'. A search bar is present. A table lists registers with columns for value, edit icon, and date. The 'Temperature_Oven_1' register has a value of 502 and a date of 2017-02-09 12:38. An 'Edit Register' modal is open, showing 'Register Address [2048-4095]*' with the value 2049 and 'Register Value [0-65535]*' with the value 180. A 'SAVE' button is at the bottom right of the modal.

Value	Edit Icon	Date
\$2048		2017-02-09 12:45
Temperature_Oven_1		2017-02-09 12:38

Register Address [2048-4095]*	Register Value [0-65535]*
2049	180

Premere icona di editazione

Editare valore e salvare

SAVE

Editare registro nel DIACloud APP

The screenshot shows the DIACloud APP interface. At the top, there's a header with 'Test' and navigation icons. Below it, there are tabs for 'Details' and 'Registers'. A table lists registers with columns for 'Addr.' and 'Value'. The '2048' register has a value of 32 and the '2049' register has a value of 33. Edit icons are visible next to each row.

Addr.	Value
2048	32
2049	33

Premere icona di editazione





DX Funzioni Avanzate del Registro

1. Selezionare "Config"

DX2100_F0F8

OVERVIEW **REGISTERS** SERVICES MORE

Search 1/1

\$2048	376 2017-02-09 12:45	⋮
Temperature_Oven_1	OK 2017-02-09 15:09	⋮

- History
- Delete
- Config**

2. Personalizzare nome del registro in funzione del valore via JavaScript

Register Configuration

Register Address: 2049

Alias Name*: Temperature_Oven_1

```
function(val) {  
  JavaScript Template  
  if (val < 80)  
    return "OK";  
  else if (val < 100)  
    return "High";  
  else if (val > 100)  
    return "Too_High";  
}
```

SAVE

3. Valore del registro cambia come regolato

DX2100_F0F8

OVERVIEW **REGISTERS** SERVICES MORE

Search 1/1

\$2048	376 2017-02-09 12:45	⋮
Temperature_Oven_1	High 2017-02-09 15:14	⋮



3.3 Configurazione DIACom



Configurazione DIACom

1. Login DIACom

example@example.com

password

Remember [Forgot?](#)

Log In

[Sign up for DIACloud](#)

Opzione Proxy HTTP

2. Configurare Proxy HTTP se necessario

HTTP Proxy

IP Address Port

User name Password

Diagnose Save Back

3. Collegare il PC locale al DIACloud

Selezionare il tunnel sicuro che è già stato creato nel DIACloud website

1. Impostare l'IP statico o DHCP.
2. Si raccomanda di usare il DHCP per evitare la duplicazione degli IP.

Status	Name	SN	Latency	IP Address	Operation
Online	DX2100_F0F8	DXR02010F270075	161 ms	192.168.200.136	
Online	DX2300_TEST_BCN	DXL02040F2D0050	656 ms	192.168.200.112	
Offline	DX2100_E73C	DXR02030F2B0029	-	192.168.200.180	

1. Fai clic su "Crea tunnel" per creare una connessione sicura tra DIACom e il server DIACloud
2. Attendere che il processo di connessione venga completato.

4. DX router, configurazione porta seriale

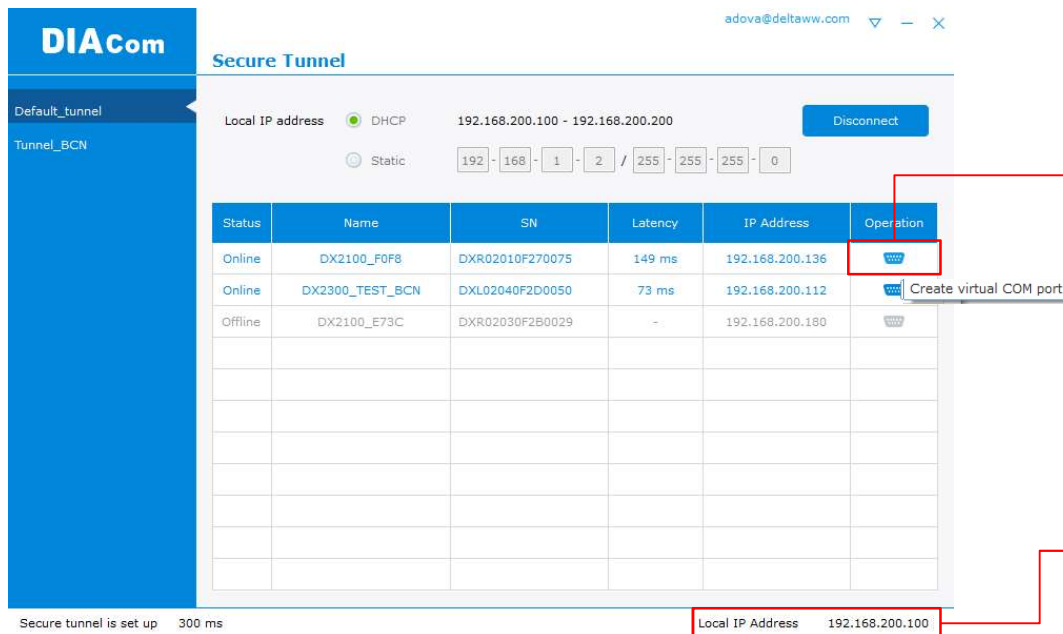

adova@deltaww.com

DIACom Secure Tunnel

Default_tunnel
Tunnel_BCN

Local IP address DHCP 192.168.200.100 - 192.168.200.200

Static: 192 - 168 - 1 - 2 / 255 - 255 - 255 - 0

Status	Name	SN	Latency	IP Address	Operation
Online	DX2100_F0F8	DXR02010F270075	149 ms	192.168.200.136	<input type="button" value="Create virtual COM port"/>
Online	DX2300_TEST_BCN	DXL02040F2D0050	73 ms	192.168.200.112	<input type="button" value="Create virtual COM port"/>
Offline	DX2100_E73C	DXR02030F2B0029	-	192.168.200.180	<input type="button" value="Create virtual COM port"/>

Secure tunnel is set up 300 ms

Local IP Address 192.168.200.100

1. Se si collega il router DX al pc tramite Ethernet, non è necessario modificare altro in questa pagina.
2. Se si collega il router DX al pc via RS-232 o RS-485, è necessario creare una COM "virtuale"

L'IP "virtuale" del PC assegnato dal DIACloud

1. Configurare COMMGR

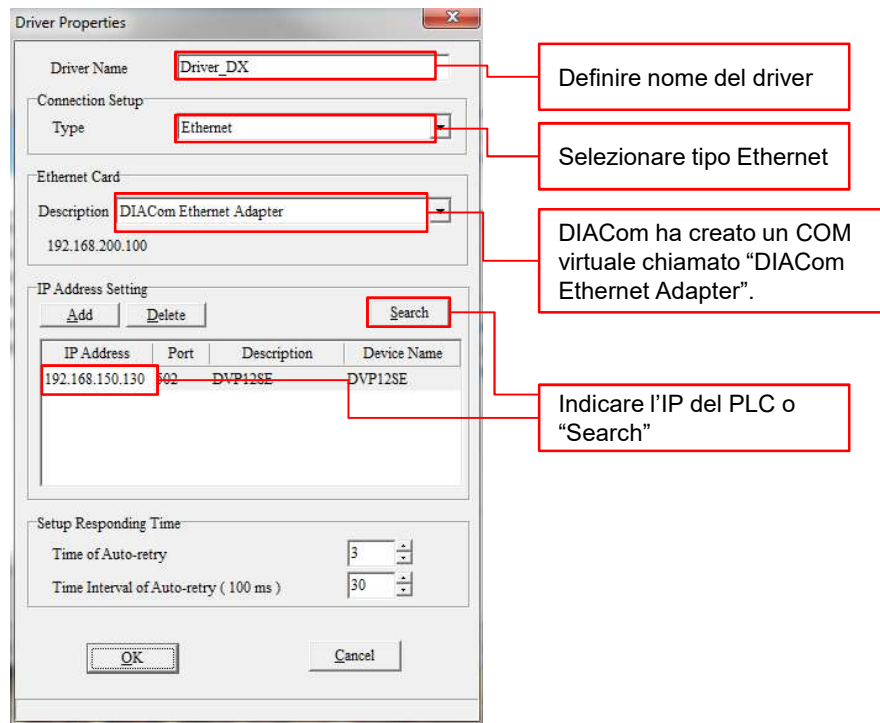

Definire nome del driver

Selezionare tipo Ethernet

DIACom ha creato un COM virtuale chiamato "DIACom Ethernet Adapter".

Indicare l'IP del PLC o "Search"

2. Configurare la comunicazione nel I/SPSoft

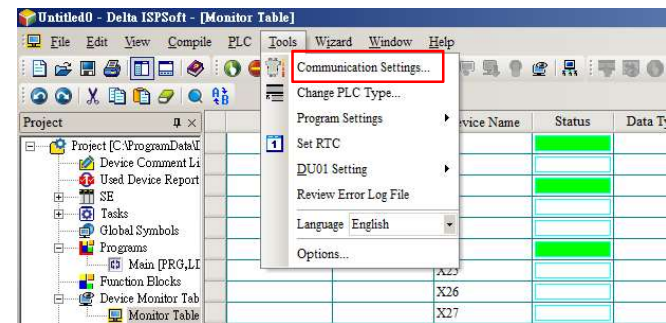
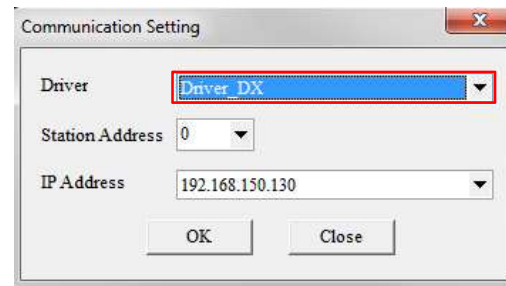

Connettere via RS-485

1. Confermare l'RS485 Mode come "Transparent mode"

DX2100_F0F8

OVERVIEW | REGISTERS | SERVICES | MORE

IP Address	192.168.200.136
Secure Tunnel	Default_tunnel
Boot Time	2017-2-9 10:47 (+1)
RS232 Mode	Closed
RS485 Mode	Transparent
Modbus TCP	Client
RSSI	

2. Creare COM virtuale

DIAcom Virtual COM Port

adova@deltaww.com

Default_tunnel | Tunnel_BCN

Device Name: DX2100_F0F8 - Online Back

IP Address: 192.168.200.136 846 ms

RS-485

COM Port: PP1 Create

COM Port: Baudrate Stop Bits

Data Bits: Parity Bits Status

RS-232

COM Port: Create

COM Port: Baudrate Stop Bits

Data Bits: Parity Bits Status

Secure tunnel is set up 373 ms Local IP Address 192.168.200.100



Connettere via RS-485

1. Configurare COMMGR

The screenshot shows the 'Driver Properties' dialog box with the following settings:

- Driver Name: Driver2
- Connection Setup Type: RS232/422/485
- Communication Protocol COM Port: COM5
- Data Length: 8
- Parity: e
- Stop Bits: 1
- Baud Rate: 9600
- Time of Auto-retry: 5
- Time Interval of Auto-retry (100 ms): 30

Annotations in red boxes point to the following fields:

- Driver Name: Definire il nome del driver
- Connection Setup Type: Selezionare RS232/422/485
- Communication Protocol COM Port: 1. Selezionare la COM "x" creata nel DIACom

2. Configurare la comunicazione nell'ISPSOFT

The screenshot shows the ISPSOFT interface with the 'Communication Settings...' menu option highlighted in the 'Tools' menu.

The screenshot shows the 'Communication Setting' dialog box with the following settings:

- Driver: Driver2
- Station Address: 1
- IP Address: 192.168.200.2



3.4 Configurazione eventi di allarme



Evento di Allarme

1. Selezionare SYSTEM → “Privilege Management”



2. Immettere il numero del centro messaggi “SMS” (dell’operatore telefonico 3G)

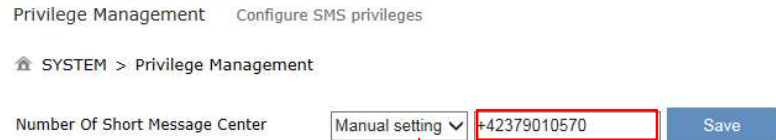

1. Selezionare l’opzione “Auto” e salvare
2. Se l’ “Auto” non funziona, impostarlo manualmente
3. Immettere il numero SMSC (Short Message Service Center) del provider 3G.
4. Esempio: Il formato del numero SMSC è **+42379010570**
Dove: +42 è il codice del paese



Evento di Allarme

4. Premere “Add A Telephone Number” in “Control List Of Event Management”

Privilege Management Configure SMS privileges

SYSTEM > Privilege Management

Number Of Short Message Center:

Short Message Control Gateway

ID	Name	Telephone Number	Operation Privileges	Enabled	Short Message Reply	Operation
----	------	------------------	----------------------	---------	---------------------	-----------

Short Message Controlling PLC

ID	Name	Telephone Number	Enabled	Short Message Reply	Operation
----	------	------------------	---------	---------------------	-----------

Control List Of Event Management

ID	Name	Telephone Number	Email	Operation
1	Alejandro	0034664212911	adova@deltaww.com	Edit Delete
2	Joan	0034618582630	JuanFrancisco.Jimenez@deltaww.com	Edit Delete
3	Enric	0034663822116		Edit Delete
4	Giuliano	00393209718856	gcastioni@deltaww.com	Edit Delete
5	Nacho	0034667461694	iromero@mecmod.com	Edit Delete

5. Aggiungi un nuovo utente

Privilege Management configure SMS privileges

SYSTEM > Privilege Management

Add A New User Of Event Management

Name

Telephone Number

Email

Inserisci il Nome dell'utente

Inserisci il numero di cellulare. • Il formato del numero di telefono è:
0034664212911 •
0034: prefisso internazionale di chiamata
664212911: numero di cellulare

Inserisci l'email

6. Confermare l'utente creato

Number Of Short Message Center Manual setting +886932400821

Short Message Control Gateway

選擇檔案 未選擇任何檔案

ID	Name	Telephone Number	Operation Privileges	Enabled	Short Message Reply	Operation
1	usa	0018137773222			godsjerry@gmail.com	Edit Delete

Short Message Controlling PLC

選擇檔案 未選擇任何檔案

ID	Name	Telephone Number	Enabled	Short Message Reply	Operation
----	------	------------------	---------	---------------------	-----------

Control List Of Event Management

選擇檔案 未選擇任何檔案

ID	Name	Telephone Number	Email	Operation
1	usa	0018137773222	godsjerry@gmail.com	Edit Delete



Allarmi Evento

7. Selezionare SYSTEM → Event Management → Alarm Event

The screenshot shows the Delta DX-2100 web interface. The top navigation bar includes 'DX-2100', 'STATUS', 'NETWORK', 'FIREWALL', 'SYSTEM' (highlighted with a red box), and 'CLOUD SERVICE'. The left sidebar contains various management options, with 'Event Management' highlighted. The main content area shows 'Event Management' settings, including 'Event Type' set to 'Alarm event' (highlighted with a red box) and a table of alarm configurations.

Alarm Name	Alarm Description	Alarm Criteria	Target Receiver
D1Register	Over100	{\$2049}>100	IABG@deltaww.com,Jer...

8. Impostazione evento di allarme

The screenshot shows the 'Alarm Event' configuration page. The 'Alarm Name' is 'PruebaSMS' and the 'Alarm Description' is 'Temp_Overload'. The 'Alarm Criteria' field contains the expression '{\$2049}>100', which is highlighted with a red box and annotated with a callout: 'Criterio di Allarme: {\$XXXX}>100'. The 'Event Interval' is set to 10 minutes and 'Repeat Times' to 2. The 'Alarm Status' is 'Enable'. The 'Alarm Content' field shows a template with fields for Time, Date, Name, and Description, and the text 'Temp_Overload'. The 'Target Receiver' field has checkboxes for 'Alejandro', 'Joan', 'Enric', 'Giuliano', and 'Nacho', with 'Alejandro' and 'Enric' selected. A red box around the checkboxes is annotated with 'Selezionare i destinatari dell'allarme'. 'Save' and 'Back' buttons are at the bottom.

9. Se il valore del registro supera 100 verrà inviata l'email ed il numero di telefono per l'SMS riceverà la segnalazione.



Storico messaggi di allarme

1. Selezionare "ALARMS"



2. Messaggi di allarme nel DIACloud

#	Device Name	Alarm Message	Status	Created
1	VFDControl DXR02010F210059	!!!!!!!WARNING!!!!!!! VFD Status : Emergency Stopped Time : 2016/03/14 18:28 MS300 has been stopped, please contact the relevant member!!!	✓	2016-03-14 18:18:31
2	VFDControl DXR02010F210059	!!!!!!!WARNING!!!!!!! VFD Status : Emergency Stopped Time : 2016/03/14 18:25 MS300 has been stopped, please contact the relevant member!!!	✓	2016-03-14 18:16:41
3	HMI DXR02010F210039	01 2016/03/14 18:15:42	✓	2016-03-14 18:16:15



Messaggi di allarme nell'APP

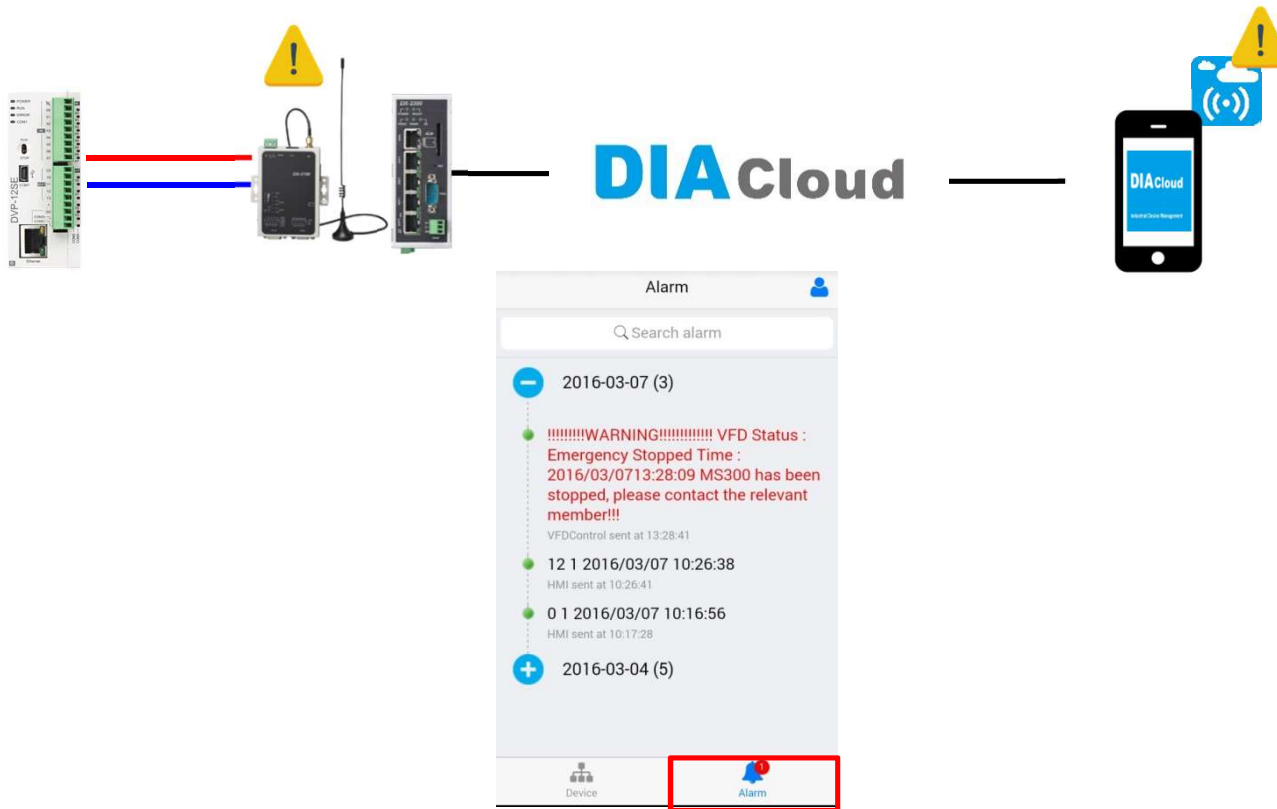



YOUTUBE



VISITA IL NOSTRO NUOVO CANALE





DOMANDE?

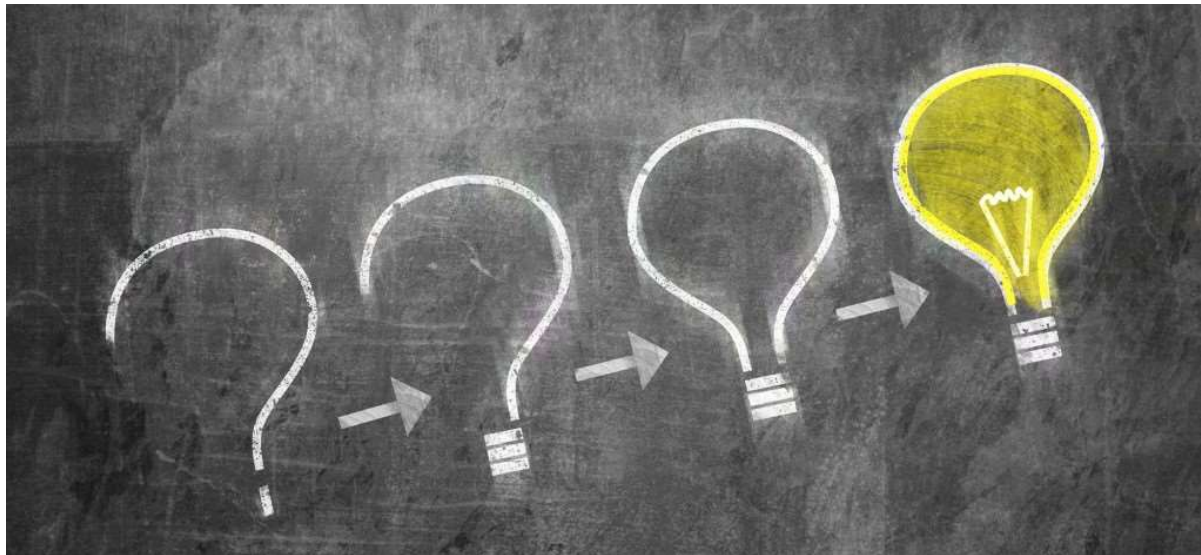

Smarter. Greener. Together.

To learn more about Delta, please visit www.deltaww.com.

